

教學創新精進子計畫：A1建置跨域學習共構校園

NODE-RED感測網路領域之實務

啟動數據之眼：政府公開資料運用於感測網路基礎與視覺化儀表板

趙峻逸 老師

Jimmy@imi.tw

課程目標

- ◆ Node-RED基礎(4/13)
- ◆ Gemini AI 生成與分析+公開資訊抓取數據與視覺化(4/20)
- ◆ 儀表板新增折線圖與即時影像擷取(5/4)

NODE-RED 是什麼?

Node-RED 是由 IBM 開發的 **流程式 (Flow-based) 開發工具**，主要特色是：

用「**拉線流程圖**」方式寫程式

適合 **IoT**、**資料整合**、**自動化**

常用在 **感測器**、**設備控制**、**API整合**

NODE-RED 專題方向

Node-RED 可以把 **感測器**、**API**、**AI模型**、**資料庫** 用流程圖串起來，適合學生做 IoT + AI 專題。

- AI 智慧環境監測系統：AI分析空氣品質
- AI 智慧家庭 (Smart Home)：AI判斷情境
- AI影像辨識警報系統：AI影像辨識
- AI智慧農業系統：AI判斷灌溉時間
- AI客服 / AI聊天機器人：AI模型 (LLM)

NODEJS安裝

1. 下載Nodejs : <https://nodejs.org/en/download>

2. 使用CMD命令提示

`npm install -g --unsafe-perm node-red`

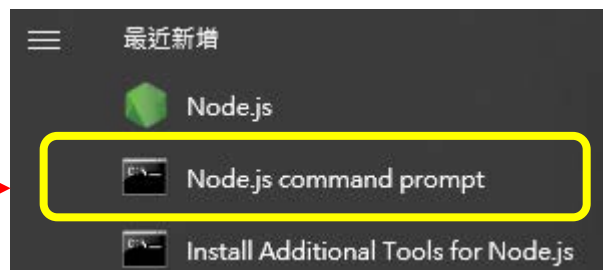

3. NodeRed啟動

`node-red`

```
Node.js command prompt
Your environment has been set up for using Node.js 24.14.1 (x64) and npm.

C:\Users\jimmy>npm install -g --unsafe-perm node-red
npm warn "node-red" is being parsed as a normal command line argument.
npm warn Unknown cli config "--unsafe-perm". This will stop working in the next major version of npm.

added 275 packages in 1m

53 packages are looking for funding
  run `npm fund` for details
npm notice
npm notice New minor version of npm available! 11.11.0 -> 11.12.1
npm notice Changelog: https://github.com/npm/cli/releases/tag/v11.12.1
npm notice To update run: npm install -g npm@11.12.1
npm notice

C:\Users\jimmy>
```

```
node-red
12 Apr 09:05:38 - [info] Node-RED version: v4.1.8
12 Apr 09:05:38 - [info] Node.js version: v24.14.1
12 Apr 09:05:38 - [info] Windows_NT 10.0.19045 x64 LE
12 Apr 09:05:39 - [info] Loading palette nodes
12 Apr 09:05:40 - [info] Settings file : C:\Users\jimmy\.node-red\settings.js
12 Apr 09:05:40 - [info] Context store : 'default' [module=memory]
12 Apr 09:05:40 - [info] User directory : C:\Users\jimmy\.node-red
12 Apr 09:05:40 - [warn] Projects disabled : editorTheme.projects.enabled=false
12 Apr 09:05:40 - [info] Flows file : C:\Users\jimmy\.node-red\flows.json
12 Apr 09:05:40 - [info] Creating new flow file
12 Apr 09:05:40 - [warn]

-----
Your flow credentials file is encrypted using a system-generated key.

If the system-generated key is lost for any reason, your credentials
file will not be recoverable, you will have to delete it and re-enter
your credentials.

You should set your own key using the 'credentialSecret' option in
your settings file. Node-RED will then re-encrypt your credentials
file using your chosen key the next time you deploy a change.
-----
12 Apr 09:05:40 - [info] Server now running at http://127.0.0.1:1880/
12 Apr 09:05:40 - [warn] Encrypted credentials not round
12 Apr 09:05:40 - [info] Starting flows
12 Apr 09:05:40 - [info] Started flows
```

Windows 安全性警訊

Windows Defender 防火牆已封鎖此應用程式的部分功能

Windows Defender 防火牆已在所有公用及私人網路上封鎖 Node.js JavaScript Runtime 的部分功能。

	名稱(N): Node.js JavaScript Runtime
	發行者(P): Node.js
	路徑(H): C:\program files\nodejs\node.exe

允許 Node.js JavaScript Runtime 在這些網路上通訊:

- 私人網路，例如家用或工作場所網路(R)
- 公用網路，例如機場和咖啡廳網路 (這些網路的安全性通常比較低或沒有任何安全性，因此不建議使用)(U)

[允許應用程式通過防火牆的風險為何?](#)

NODE-RED 初始畫面

開啟瀏覽器，輸入：<http://127.0.0.1:1880>

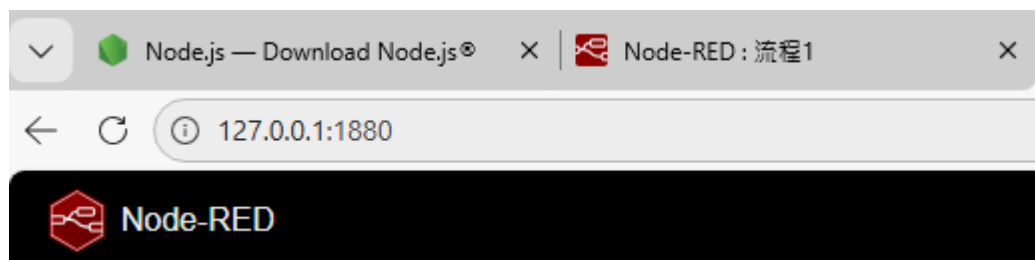

Enable Update Notifications

Node-RED can notify you when there is a new version available. This ensures you keep up to date with the latest features and fixes.

This requires sending anonymised data back to the Node-RED team. It does not include any details of your flows or users.

For full information on what information is collected and how it is used, please see the [documentation](#).

You can change this setting at any time in the User Settings.

Yes, enable notifications

No, do not enable notifications

基礎操作練習

The image shows the Node-RED web interface. At the top left, the Node-RED logo and name are visible. The main workspace is titled '流程1' (Flow 1) and contains a workflow with two nodes: a blue '時間戳' (Timestamp) node and a green 'debug 1' node, connected by a line. The left sidebar shows a search bar '過濾已安裝模組' and a list of nodes under the '共通' (Common) category, including 'inject', 'debug', 'complete', 'catch', 'status', 'link in', and 'link call'. The right sidebar is the '除錯窗口' (Debug Console), which displays a log entry: '2026/4/12 上午9:17:13 node: debug 1 msg.payload : number'. The console also has a filter dropdown set to '所有節點' (All nodes) and a 'all' button.

認識訊息流結構

msg : 訊息流 (msg可以自建任意屬性ex msg.url 、 msg.date)

payload : 訊息流本文部分

topic : 訊息流名稱

The screenshot shows a workflow editor interface. On the left, a workflow canvas displays two nodes: '時間戳' (Timestamp) and 'debug 1'. The '時間戳' node is highlighted with an orange border. On the right, the '編輯 inject 節點' (Edit inject node) panel is open. It features a '名稱' (Name) field containing '名稱'. Below this, there are two configuration rows for the 'msg' object: the first row sets 'msg.payload' to 'milliseconds since epoch', and the second row sets 'msg.topic' to 'a_z'. The panel includes buttons for '刪除' (Delete), '取消' (Cancel), and '完成' (Done), along with icons for settings, save, and refresh.

A vertical dropdown menu is shown, currently displaying 'milliseconds since epoch'. The menu items include: 'flow.', 'global.', 'a_z 文字列', '0-9 數字', '布林', 'JSON', '01/10 二進位流', '時間戳記', '表達式', '環境變量', and 'msg.'. The '時間戳記' (Timestamp) option is highlighted with a grey background.

注入資料抓取特定資訊

```
{"temp":35, "humi":65,"light":520}
```

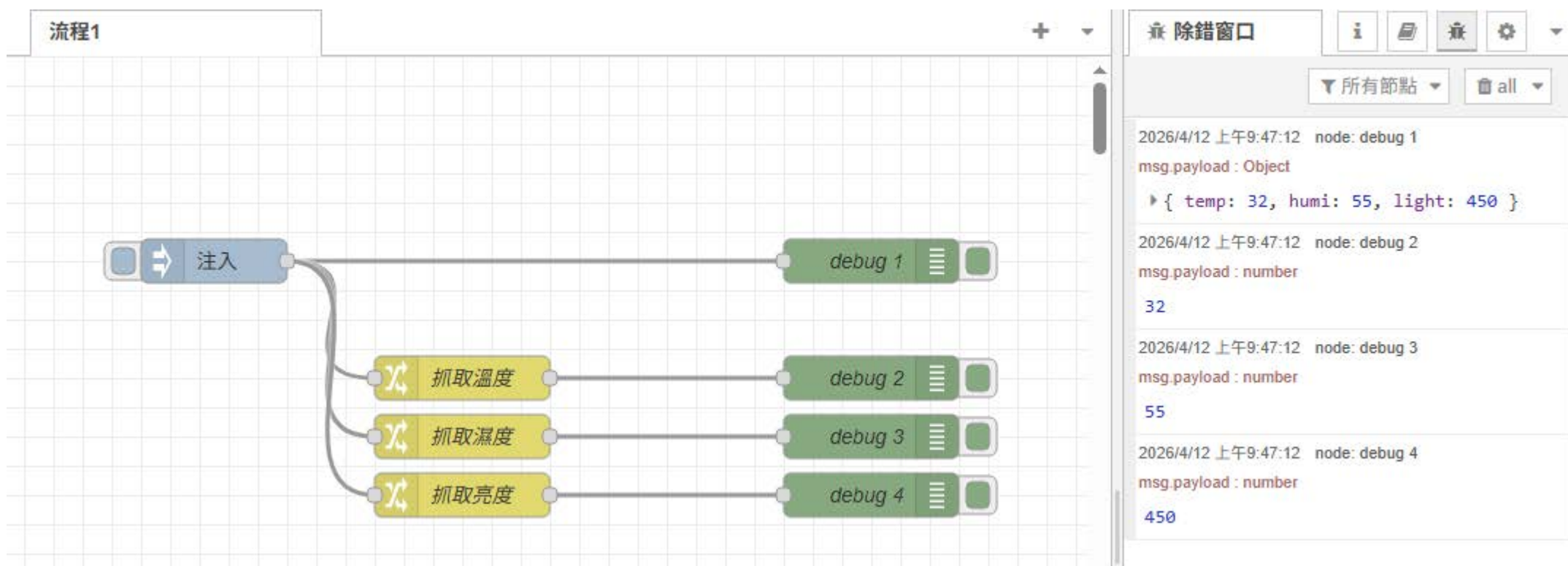

RANGE

range : 用來改變範圍 (亮度值通常在0-4095之間, 轉到0 - 100%)

0=最亮 4095=最暗

流程1

編輯 range 節點

刪除 取消 完成

屬性

屬性: msg.payload

操作: 按比例msg.payload

映射輸入資料:

從: 0 到: 4095

至目標範圍:

從: 100 到: 0

取最接近整數?

除錯窗口

所有節點 all

2026/4/12 上午9:53:08 node: debug 1
msg.payload : Object
▶ { temp: 32, humi: 55, light: 450 }

2026/4/12 上午9:53:08 node: debug 2
msg.payload : number
32

2026/4/12 上午9:53:08 node: debug 3
msg.payload : number
55

2026/4/12 上午9:53:08 node: debug 4
msg.payload : number
89.01098901098901

2026/4/12 上午9:53:26 node: debug 1
msg.payload : Object
▶ { temp: 32, humi: 55, light: 450 }

SWITCH設定條件

Switch：類似if功能，用於設定資訊流走向。

The image displays a workflow editor interface. On the left, a workflow named "流程1" (Flow 1) is shown. It starts with a "抓取溫度" (Fetch Temperature) node, which branches into three paths: one leading to "debug 1", another to "debug 2", and a third to "debug 5". A "抓取亮度" (Fetch Brightness) node leads to a "亮度" (Brightness) node, which then connects to "debug 4". A "抓取濕度" (Fetch Humidity) node leads to a "濕度警報" (Humidity Alert) node. This node is connected to three output nodes: "危險警報" (Danger Alert), "異常警報" (Abnormal Alert), and "正常警報" (Normal Alert).

On the right, the "編輯 switch 節點" (Edit Switch Node) dialog is open. It features a "名稱" (Name) field set to "濕度警報" (Humidity Alert) and a "屬性" (Property) dropdown set to "msg.payload". Below these are three conditions for routing the flow:

- Condition 1: Operator ">=" (Greater than or equal to) with a value of "70", leading to output "1".
- Condition 2: Operator "在之間" (Between) with a range from "70" to "50", leading to output "2".
- Condition 3: Operator "除此以外" (Except for), leading to output "3".

At the bottom of the dialog, there is a "+ 添加" (Add) button, a dropdown menu set to "全選所有規則" (Select all rules), a checkbox for "重建資訊佇列" (Rebuild message queue), and a radio button for "有效" (Valid).

實際運作

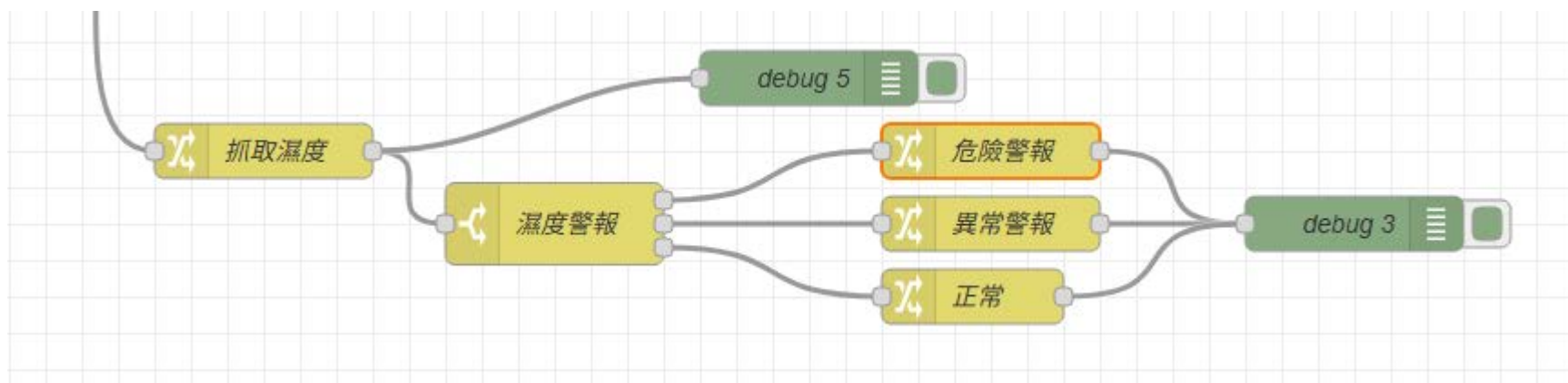

```
2026/4/12 上午10:39:24 node: debug 1  
msg.payload : Object  
  ▶ { temp: 32, humi: 30, light: 450 }  
2026/4/12 上午10:39:24 node: debug 2  
msg.payload : number  
32  
2026/4/12 上午10:39:24 node: debug 5  
msg.payload : number  
30  
2026/4/12 上午10:39:24 node: debug 4  
msg.payload : number  
89  
2026/4/12 上午10:39:24 node: debug 3  
msg.payload : string[6]  
"濕度安全範圍"
```

DELAY延遲

delay：延遲發送訊息，可以用來延遲重複發送。

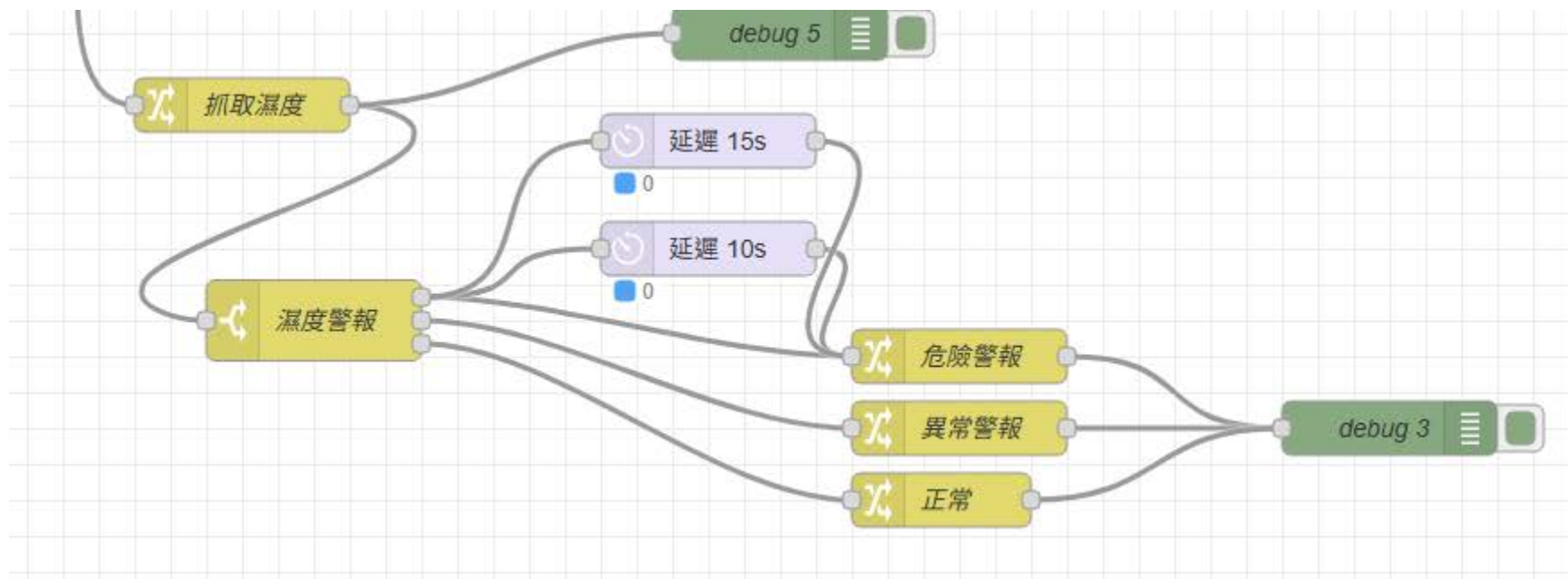

```
2026/4/12 上午11:16:50 node: debug 4  
msg.payload: number  
89  
2026/4/12 上午11:16:50 node: debug 3  
msg.payload: string[4]  
"濕度超標"  
2026/4/12 上午11:17:00 node: debug 3  
msg.payload: string[4]  
"濕度超標"  
2026/4/12 上午11:17:05 node: debug 3  
msg.payload: string[4]  
"濕度超標"
```

TRIGGER

trigger : 當**沒有資料**進來時發送訊息。

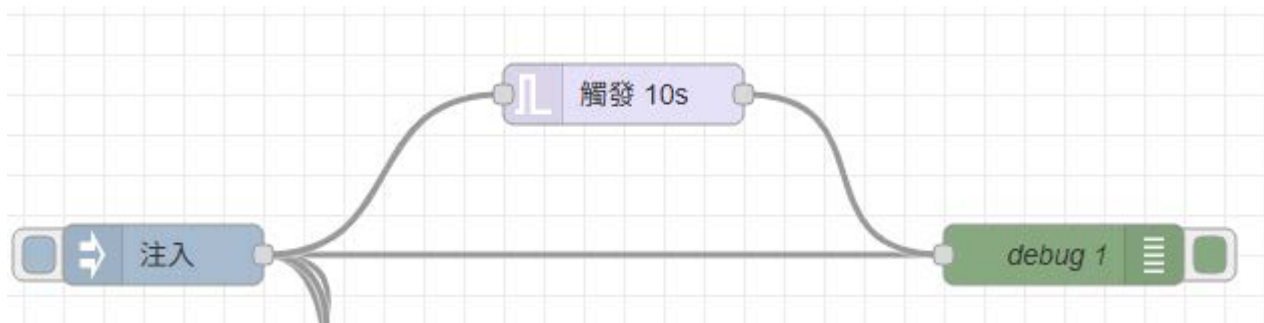

除錯窗口

所有節點

all

2026/4/12 上午11:52:35	node: debug 4	msg.payload : number 89
2026/4/12 上午11:52:35	node: debug 3	msg.payload : string[6] "濕度安全範圍"
2026/4/12 上午11:52:45	node: debug 1	msg.payload : string[8] "無資料傳入請檢查"
2026/4/12 上午11:53:23	node: debug 1	msg.payload : Object { temp: 32, humi: 20, light: 450 }
2026/4/12 上午11:53:23	node: debug 2	msg.payload : number 32
2026/4/12 上午11:53:23	node: debug 5	msg.payload : number 20
2026/4/12 上午11:53:23	node: debug 1	msg.payload : string[1] "1"
2026/4/12 上午11:53:23	node: debug 4	msg.payload : number 89

FILTER過濾器

filter：當資料都一樣時停止，直到出現變化才執行。

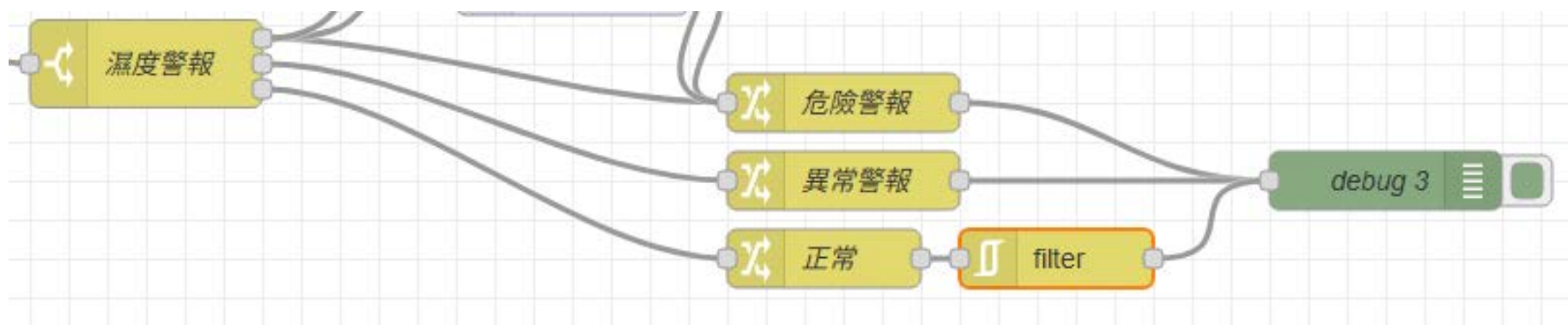

GEMINI AI 生成與分析

接續上週進度

匯入上週記錄檔：<https://bt.imi.tw/yd0416.txt>

The screenshot displays the Node-RED interface. At the top, a dark menu bar contains '部署' (Deploy) and a hamburger menu icon. Below it, a sidebar lists various actions: '編輯' (Edit), '顯示' (Show), '布局' (Layout), '匯入' (Import) with shortcut 'ctrl-i', '匯出' (Export) with shortcut 'ctrl-e' (highlighted with a red box), '搜尋流程' (Search Flow) with shortcut 'ctrl-f', '修改節點配置' (Modify Node Configuration) with shortcut 'ctrl-g c', '流程' (Flow), '子流程' (Sub-flow), '組' (Group), '節點管理' (Node Management) with shortcut 'alt-⬆️', '設置' (Settings) with shortcut 'ctrl-,', and '鍵盤快速鍵' (Keyboard Shortcuts) with shortcut '⬆️?'. The main area shows the '匯入節點' (Import Node) dialog. It has a '剪貼簿' (Clipboard) section with '本地' (Local) and '例子' (Example) tabs. The '本地' tab is active, showing a text area with a red border containing JSON configuration for a node:

```
{
  "timeout": 5,
  "timeoutUnits": "seconds",
  "rate": "1",
  "nbRateUnits": "1",
  "rateUnits": "second",
  "randomFirst": "1",
  "randomLast": "5",
  "randomUnits": "seconds",
  "drop": false,
  "allowrate": false,
  "outputs": 1,
  "x": 640,
  "y": 280,
  "wires": [
    [
      "76fb0acff87d421"
    ]
  ]
}
```

 Below the text area are buttons for '匯入到' (Import to), '現在的節點' (Current Node), and '新流程' (New Flow). At the bottom right of the dialog are '取消' (Cancel) and '匯入' (Import) buttons, with the '匯入' button highlighted by a red box. A red arrow points from the '匯出' button in the sidebar to the '匯入' button in the dialog.

安裝 GOOGLE GEMINI 節點

搜尋節點 node-red-contrib-gemini

The screenshot shows the Node-RED interface with the '安裝' (Install) tab selected. The search bar contains 'node-red-contrib-gemini' and shows 1/5937 results. The search results list the 'node-red-contrib-gemini' node with a description: 'Node-RED nodes for Google Gemini AI integration including text generation, chat, vision, image generation, speech generation, and audio understanding capabilities'. The version is 1.0.3, published 4 months ago, and has 47 likes. The '安裝' (Install) button is highlighted with a red box.

The screenshot shows the Node-RED keyboard shortcuts menu. The '節點管理' (Node Management) shortcut, which is 'alt-↑', is highlighted with a red box. A red arrow points from this box to the '安裝' (Install) button in the previous screenshot.

- 編輯
- 顯示
- 布局
- 匯入 `ctrl-i`
- 匯出 `ctrl-e`
- 搜尋流程 `ctrl-f`
- 修改節點配置 `ctrl-g c`
- 流程
- 子流程
- 組
- 節點管理 `alt-↑`**
- 設置 `ctrl-,`
- 鍵盤快速鍵 `↑?`
- Node-RED 文檔主頁
- v4.1.8

取得 GOOGLE GEMINI API KEY

- 開啟瀏覽器，前往 Google AI Studio。

<https://aistudio.google.com/>

- 找到

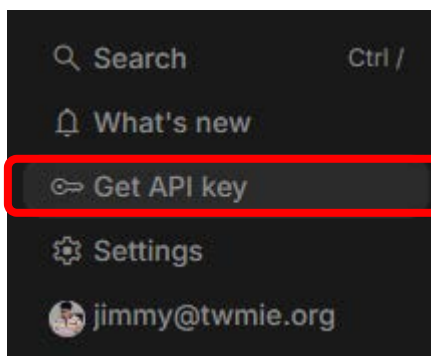

- 新增

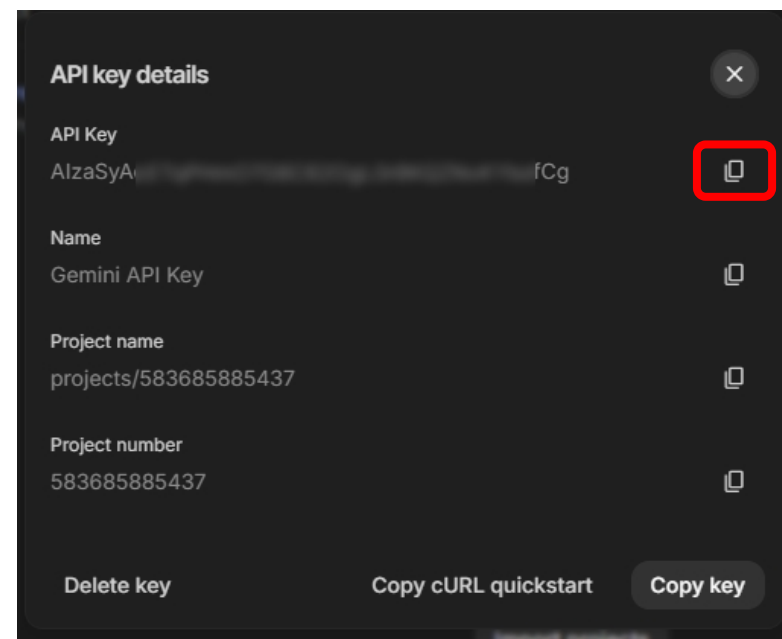
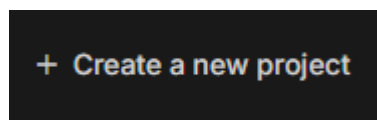

添加AI KEY

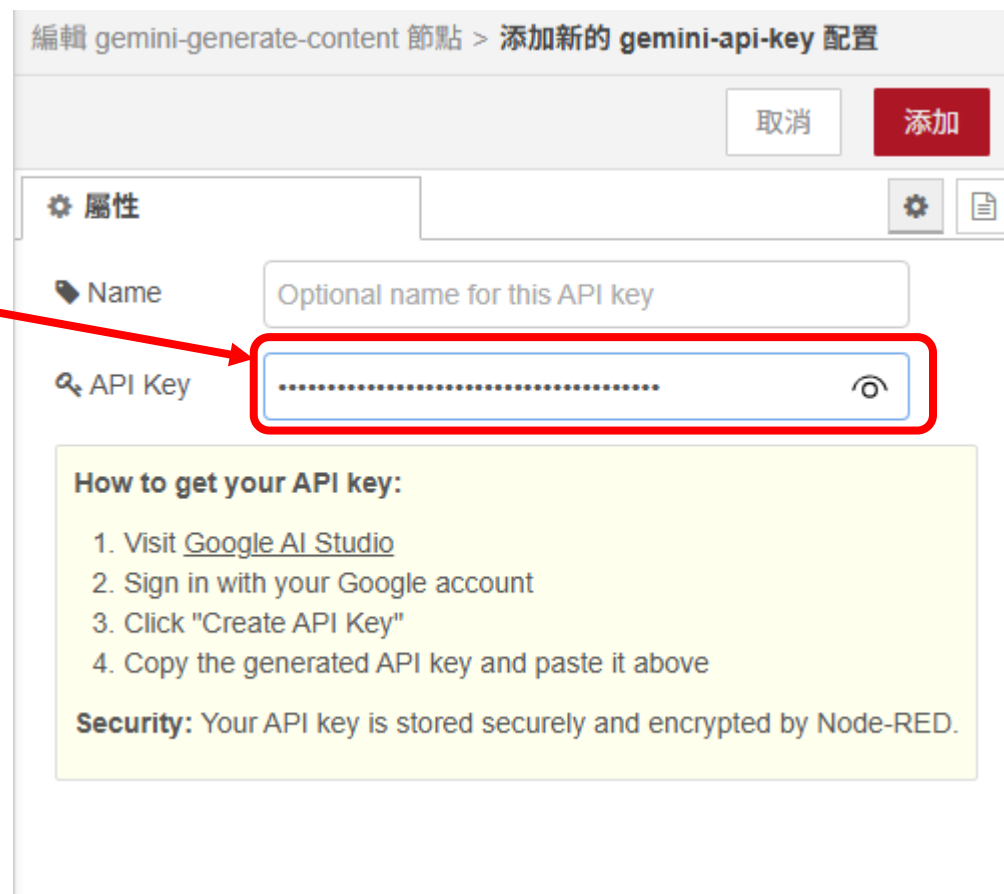
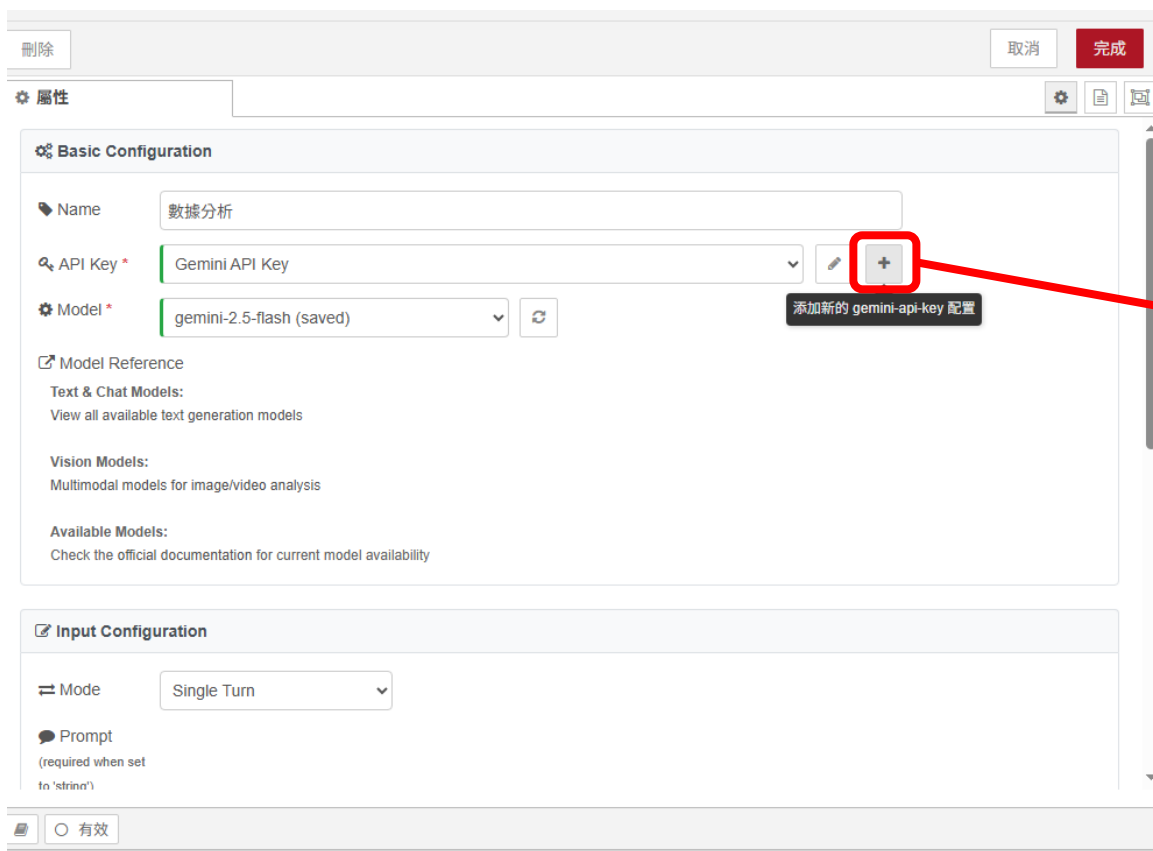

KEY: AlzaSyANjVfeXSCStrdkKSJbv3xkc872hZSjZ-U

透過 GEMINI AI 幫你寫程式

使用 Node-RED 進行 gemini AI 資料分析，我的資料為 {"temp":32, "humi":50, "light":650} 分別代表溫度、濕度及亮度。(已安裝 node-red-contrib-gemini)

```
個 Function 節點，將收到的 JSON 轉換成 AI 容易讀取的格式：  
  
JavaScript  
  
// 從 msg.payload 取得原始感測器資料  
let temp = msg.payload.temp;  
let humi = msg.payload.humi;  
let light = msg.payload.light;  
  
// -----  
// 情況 A：如果你要餵給傳統機器學習模型（如 TensorFlow）  
// 模型通常需要一維陣列（Array）作為特徵值（Features）  
let mlFeatures = [temp, humi, light];  
  
// -----  
// 情況 B：如果你要餵給生成式 AI 或大型語言模型（LLM）  
// 將數據轉換成自然語言的提示詞（Prompt）  
let aiPrompt = `目前的環境數據為：溫度 ${temp}°C，相對濕度 ${humi}%，亮度 ${light} lux`;  
  
// 將轉換後的資料覆蓋原本的 payload，傳遞給下一個節點  
//（請根據你的需求選擇輸出 mlFeatures 或 aiPrompt）  
msg.payload = aiPrompt;  
  
return msg;
```

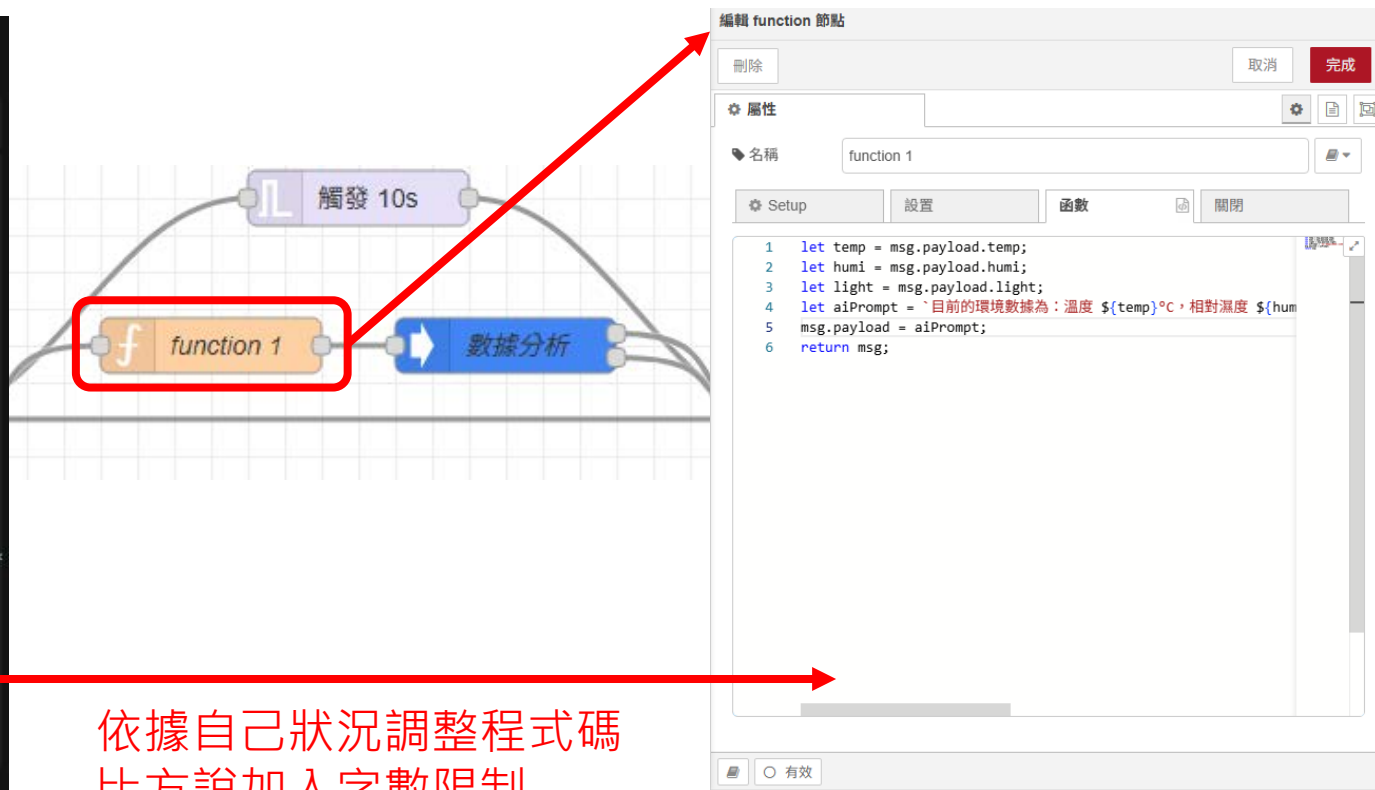

依據自己狀況調整程式碼
比方說加入字數限制

依據資料透過AI分析結果

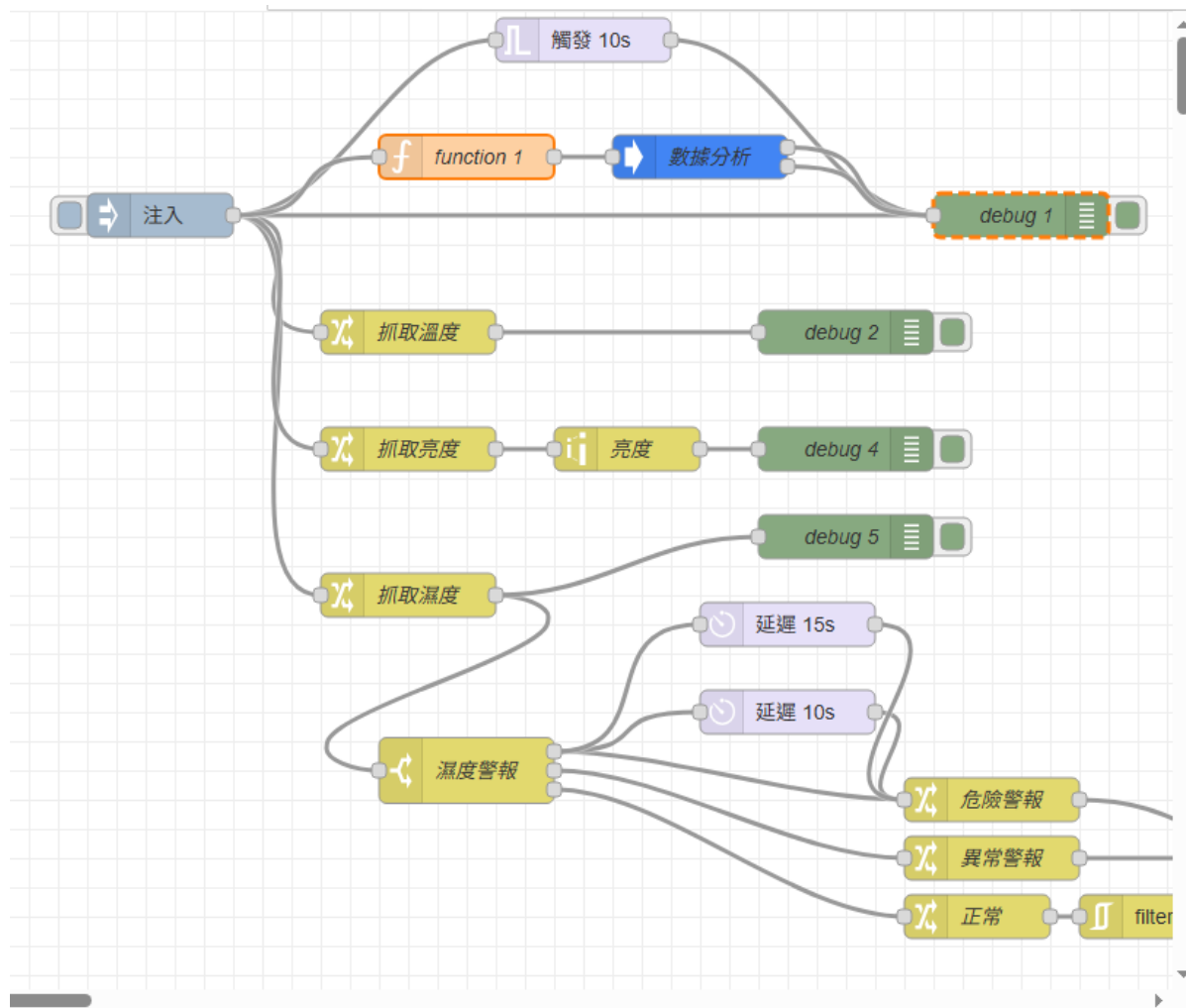

所有節點 all

環境舒適度評估：

目前的環境舒適度 ****非常低，處於極度不適的狀態****。主要問題是**高溫**和**極低的濕度**。

- **溫度 (32°C): 極度高溫****
 - **評估:**** 32°C 遠高於一般室內舒適溫度範圍 (通常為 22-26°C)。長時間處於此溫度會讓人感到酷熱、煩躁、出汗，甚至可能導致中暑或熱衰竭。這會嚴重影響工作效率和身心健康。
- **相對濕度 (20%): 極度乾燥****
 - **評估:**** 20% 的相對濕度遠低於人體舒適範圍 (通常為 40-60%)。空氣過於乾燥會導致以下問題：
 - 皮膚乾燥、發癢
 - 眼睛乾澀、不適
 - 喉嚨乾燥、咳嗽，容易引發呼吸道疾病
 - 靜電問題
 - 對木質家具和樂器等物品可能造成損害
- **亮度 (450 lux): 一般，可能稍嫌不足或合適****
 - **評估:**** 450 lux 對於一般辦公或日常活動來說，處於一個可接受但可能不算最理想的範圍。
 - **足夠:**** 對於一般休息或輕鬆活動來說，亮度足夠。
 - **稍嫌不足:**** 如果需要進行閱讀、寫作或使用電腦等需要高度專注的精細工作，450 lux 可能會稍嫌不足，容易造成眼睛疲勞。
 - 在如此高溫和乾燥的環境下，亮度的問題相對次要，但仍值得關注。

綜合評估：

目前的環境組合對人體健康和舒適度是極其不利的。高溫會使人感到悶熱難耐，而極度乾燥的空氣則會加劇不適，導致身體水分流失和各種乾燥症狀。這種環境會大大降低居住者或工作者的舒適度、生產力，並可能帶來健康風險。

建議：

務必立即採取措施改善環境條件。

- **針對高溫 (32°C):****
 - **立即開啟空調 (Air Conditioning):**** 將溫度設定在 24-26°C 的舒適範圍。
 - **使用風扇 (Fans):**** ...

啟用 Windows 移至 [設定] 以啟用 Windows。

公開資訊抓取數據與視覺化



刪除 取消 完成

屬性

請求方式 GET

URL `https://data.moenv.gov.tw/api/v2/AQX_P_488?api`

內容 Ignore

- 使用安全連接 (SSL/TLS)
- 基本認證
- 對連接啟用keep-alive
- 使用代理服務器
- Only send non-2xx responses to Catch node
- Disable strict HTTP parsing

← 返回 JSON對象

提示：如果JSON解析失敗，則獲取的字串將按原樣返回。

Header

JSON ONLINE 線上JSON 分析

網址：jsoneditoronline.org

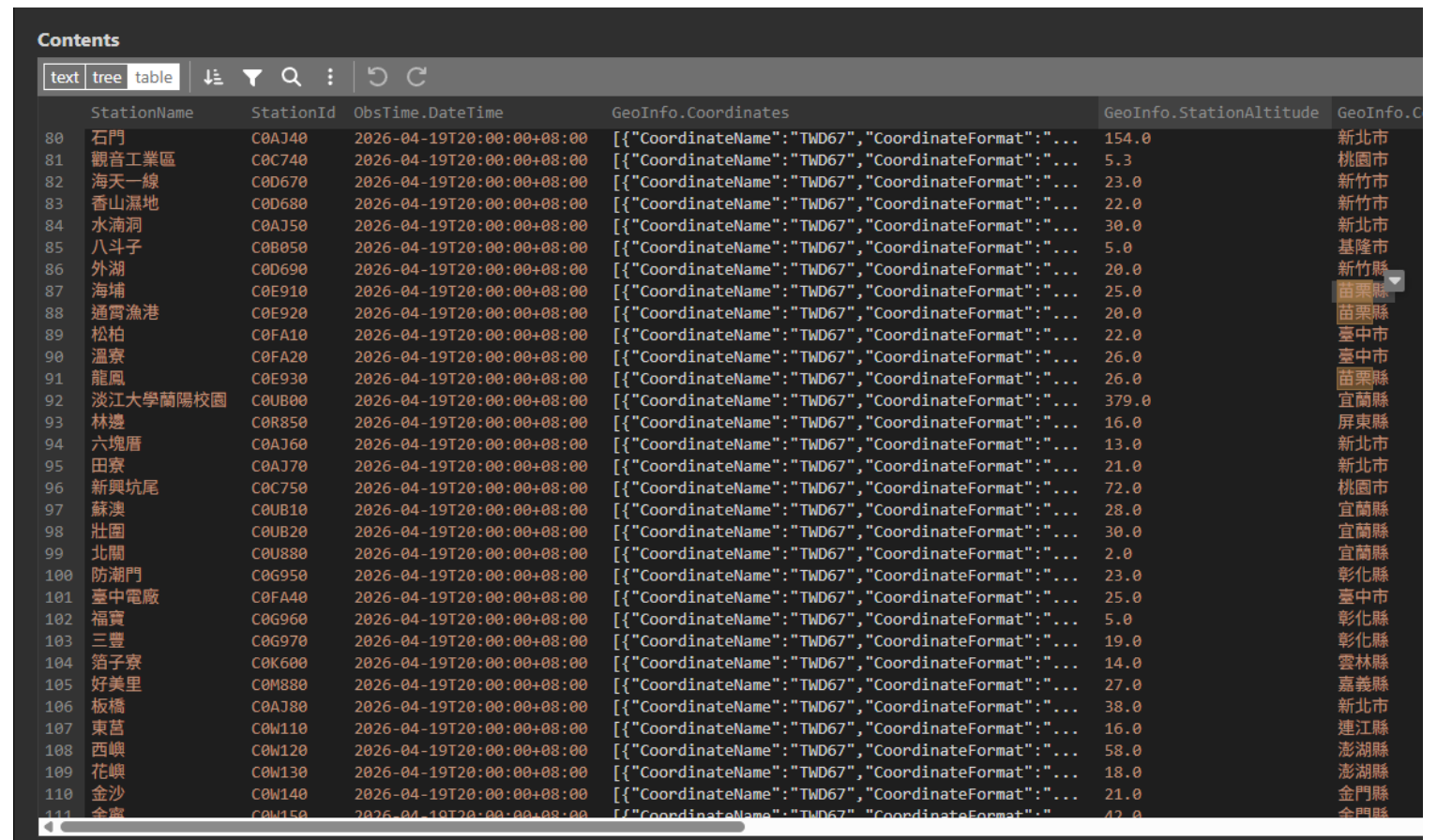

The screenshot shows the JSON Editor Online interface with a table view of station data. The table has columns for StationName, StationId, ObsTime.DateTime, GeoInfo.Coordinates, GeoInfo.StationAltitude, and GeoInfo.CityName. The data is sorted by StationId.

	StationName	StationId	ObsTime.DateTime	GeoInfo.Coordinates	GeoInfo.StationAltitude	GeoInfo.CityName
80	石門	C0A740	2026-04-19T20:00:00+08:00	[{"CoordinateName": "TWD67", "CoordinateFormat": "...	154.0	新北市
81	觀音工業區	C0C740	2026-04-19T20:00:00+08:00	[{"CoordinateName": "TWD67", "CoordinateFormat": "...	5.3	桃園市
82	海天一線	C0D670	2026-04-19T20:00:00+08:00	[{"CoordinateName": "TWD67", "CoordinateFormat": "...	23.0	新竹市
83	香山濕地	C0D680	2026-04-19T20:00:00+08:00	[{"CoordinateName": "TWD67", "CoordinateFormat": "...	22.0	新竹市
84	水湳洞	C0A750	2026-04-19T20:00:00+08:00	[{"CoordinateName": "TWD67", "CoordinateFormat": "...	30.0	新北市
85	八斗子	C0B050	2026-04-19T20:00:00+08:00	[{"CoordinateName": "TWD67", "CoordinateFormat": "...	5.0	基隆市
86	外湖	C0D690	2026-04-19T20:00:00+08:00	[{"CoordinateName": "TWD67", "CoordinateFormat": "...	20.0	新竹縣
87	海埔	C0E910	2026-04-19T20:00:00+08:00	[{"CoordinateName": "TWD67", "CoordinateFormat": "...	25.0	苗栗縣
88	通霄漁港	C0E920	2026-04-19T20:00:00+08:00	[{"CoordinateName": "TWD67", "CoordinateFormat": "...	20.0	苗栗縣
89	松柏	C0FA10	2026-04-19T20:00:00+08:00	[{"CoordinateName": "TWD67", "CoordinateFormat": "...	22.0	臺中市
90	溫寮	C0FA20	2026-04-19T20:00:00+08:00	[{"CoordinateName": "TWD67", "CoordinateFormat": "...	26.0	臺中市
91	龍鳳	C0E930	2026-04-19T20:00:00+08:00	[{"CoordinateName": "TWD67", "CoordinateFormat": "...	26.0	苗栗縣
92	淡江大學蘭陽校園	C0UB00	2026-04-19T20:00:00+08:00	[{"CoordinateName": "TWD67", "CoordinateFormat": "...	379.0	宜蘭縣
93	林邊	C0R850	2026-04-19T20:00:00+08:00	[{"CoordinateName": "TWD67", "CoordinateFormat": "...	16.0	屏東縣
94	六塊厝	C0A760	2026-04-19T20:00:00+08:00	[{"CoordinateName": "TWD67", "CoordinateFormat": "...	13.0	新北市
95	田寮	C0A770	2026-04-19T20:00:00+08:00	[{"CoordinateName": "TWD67", "CoordinateFormat": "...	21.0	新北市
96	新興坑尾	C0C750	2026-04-19T20:00:00+08:00	[{"CoordinateName": "TWD67", "CoordinateFormat": "...	72.0	桃園市
97	蘇澳	C0UB10	2026-04-19T20:00:00+08:00	[{"CoordinateName": "TWD67", "CoordinateFormat": "...	28.0	宜蘭縣
98	壯圍	C0UB20	2026-04-19T20:00:00+08:00	[{"CoordinateName": "TWD67", "CoordinateFormat": "...	30.0	宜蘭縣
99	北關	C0U880	2026-04-19T20:00:00+08:00	[{"CoordinateName": "TWD67", "CoordinateFormat": "...	2.0	宜蘭縣
100	防潮門	C0G950	2026-04-19T20:00:00+08:00	[{"CoordinateName": "TWD67", "CoordinateFormat": "...	23.0	彰化縣
101	臺中電廠	C0FA40	2026-04-19T20:00:00+08:00	[{"CoordinateName": "TWD67", "CoordinateFormat": "...	25.0	臺中市
102	福寶	C0G960	2026-04-19T20:00:00+08:00	[{"CoordinateName": "TWD67", "CoordinateFormat": "...	5.0	彰化縣
103	三豐	C0G970	2026-04-19T20:00:00+08:00	[{"CoordinateName": "TWD67", "CoordinateFormat": "...	19.0	彰化縣
104	鴉子寮	C0K600	2026-04-19T20:00:00+08:00	[{"CoordinateName": "TWD67", "CoordinateFormat": "...	14.0	雲林縣
105	好美里	C0M880	2026-04-19T20:00:00+08:00	[{"CoordinateName": "TWD67", "CoordinateFormat": "...	27.0	嘉義縣
106	板橋	C0A780	2026-04-19T20:00:00+08:00	[{"CoordinateName": "TWD67", "CoordinateFormat": "...	38.0	新北市
107	東莒	C0W110	2026-04-19T20:00:00+08:00	[{"CoordinateName": "TWD67", "CoordinateFormat": "...	16.0	連江縣
108	西嶼	C0W120	2026-04-19T20:00:00+08:00	[{"CoordinateName": "TWD67", "CoordinateFormat": "...	58.0	澎湖縣
109	花嶼	C0W130	2026-04-19T20:00:00+08:00	[{"CoordinateName": "TWD67", "CoordinateFormat": "...	18.0	澎湖縣
110	金沙	C0W140	2026-04-19T20:00:00+08:00	[{"CoordinateName": "TWD67", "CoordinateFormat": "...	21.0	金門縣
111	金寧	C0W150	2026-04-19T20:00:00+08:00	[{"CoordinateName": "TWD67", "CoordinateFormat": "...	42.0	金門縣

抓取空氣品質數據

環境部官網：<https://data.moenv.gov.tw/>

資料來源：https://data.moenv.gov.tw/api/v2/AQX_P_488?api_key=2568332f-f4e4-4cc4-b8cf-f85044b082c8

抓取苗栗空氣品質及PM2.5

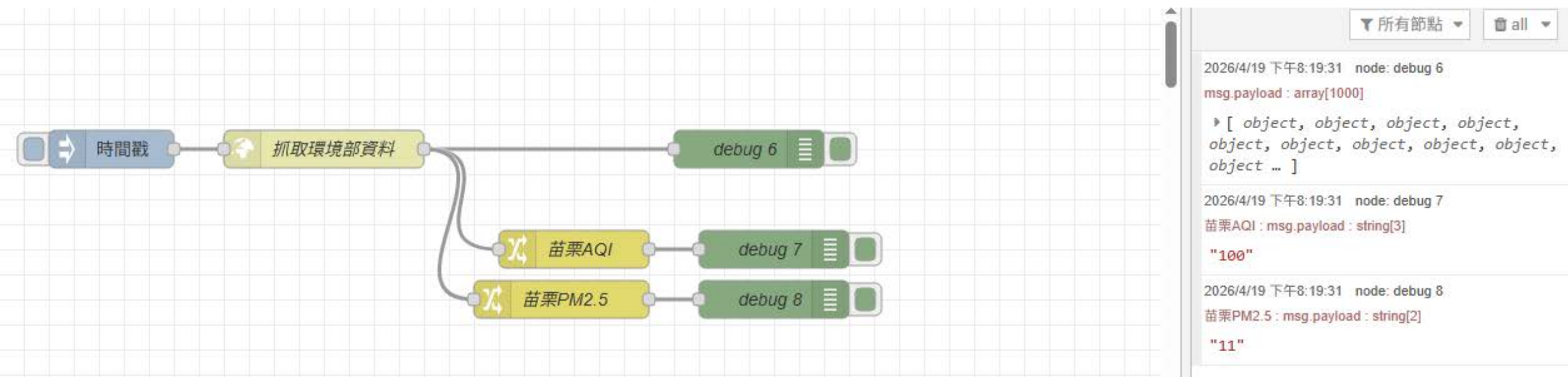

```
2026/4/19 下午8:19:31 node: debug 6  
msg.payload : array[1000]  
  ▶ [ object, object, object, object,  
      object, object, object, object,  
      object ... ]  
2026/4/19 下午8:19:31 node: debug 7  
苗栗AQI : msg.payload : string[3]  
"100"  
2026/4/19 下午8:19:31 node: debug 8  
苗栗PM2.5 : msg.payload : string[2]  
"11"
```

抓取氣象局苗栗溫度濕度

官網：<https://pweb.cwa.gov.tw/>

<https://opendata.cwa.gov.tw/api/v1/rest/datastore/O-A0001-001?Authorization=CWA-938C4B8A-8A73-47E2-9FE5-645FADCAE767>

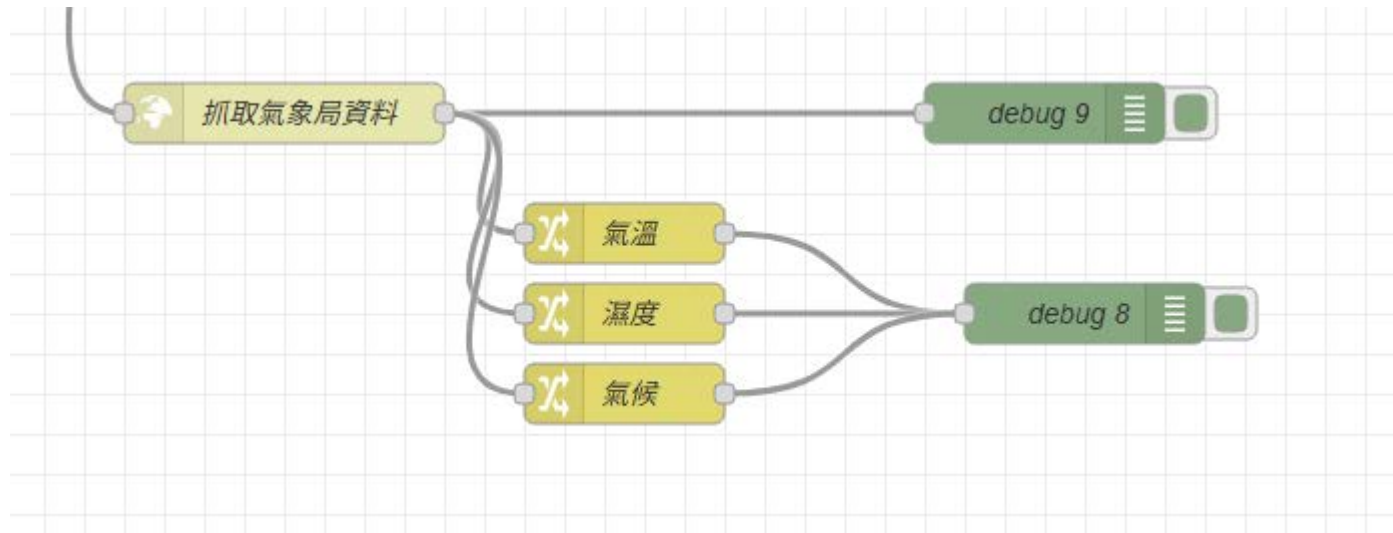

```
▼ 87: object
  StationName: "海埔"
  StationId: "C0E910"
  ▶ ObsTime: object
  ▶ GeoInfo: object
  ▼ WeatherElement: object
    氣候 Weather: "晴"
    ▶ Now: object
      WindDirection: "51.0"
      WindSpeed: "2.5"
    溫度 AirTemperature: "25.0"
    濕度 RelativeHumidity: "76"
      AirPressure: "1009.9"
    ▶ GustInfo: object
    ▶ DailyExtreme: object
  ▶ 88: object
  ▶ 89: object
  ▶ [90 ... 99]
```

空氣品質

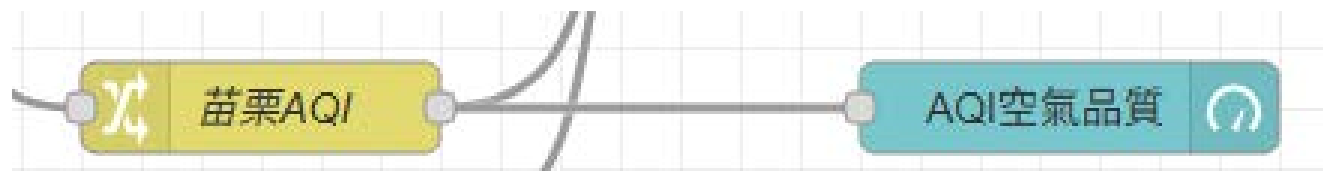
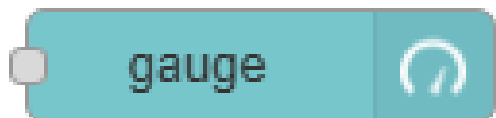

編輯 gauge 節點

刪除

取消

完成

屬性

Group

[空氣品質與天氣] 苗栗

Size

4 x 4

Type

Donut

Label

AQI空氣品質

Value format

{{value}}

Units

optional sub-label

Range

min 0

max 200

Colour gradient



Sectors

0

...

100

...

150

...

200

Class

Optional CSS class name(s) for widget

Name



○ 有效

PM2.5



單位： $\mu\text{g}/\text{m}^3$

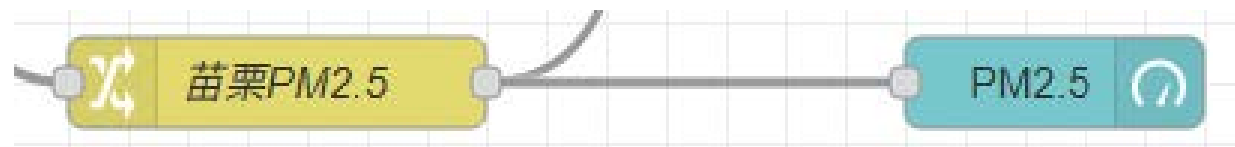

編輯 gauge 節點

刪除

取消

完成

⚙ 屬性

🗑 Group

[空氣品質與天氣] 苗栗

📏 Size

4 x 4

☰ Type

Donut

📄 Label

PM2.5

📄 Value format

{{value}}

📄 Units

$\mu\text{g}/\text{m}^3$

Range

min 0

max 100

Colour gradient



Sectors

0

...

15

...

36

...

100

</> Class

Optional CSS class name(s) for widget

📄 Name



○ 有效

氣溫

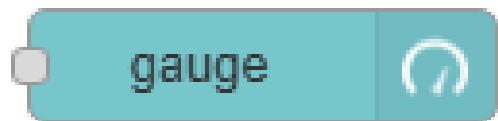

單位：C



編輯 gauge 節點

刪除

取消

完成

屬性

Group

[空氣品質與天氣] 苗栗

Size

4 x 4

Type

Compass

Label

氣溫

Value format

{{value}}

Units

C

Range

min 0

max 40

Class

Optional CSS class name(s) for widget

Name



有效

濕度

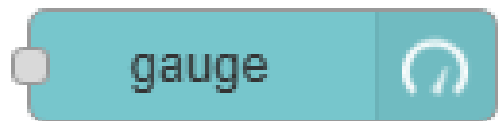

單位：%



編輯 gauge 節點

刪除

取消

完成

屬性

Group

[空氣品質與天氣] 苗栗

Size

4 x 4

Type

Level

Label

濕度

Value format

{{value}}

Units

%

Range

min 0

max 100

Class

Optional CSS class name(s) for widget

Name



有效

苗栗

前台

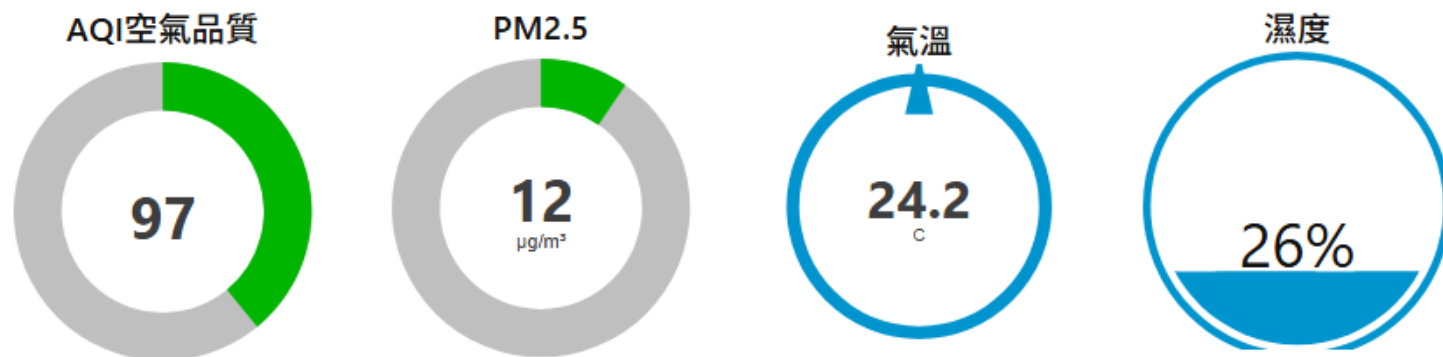

後台

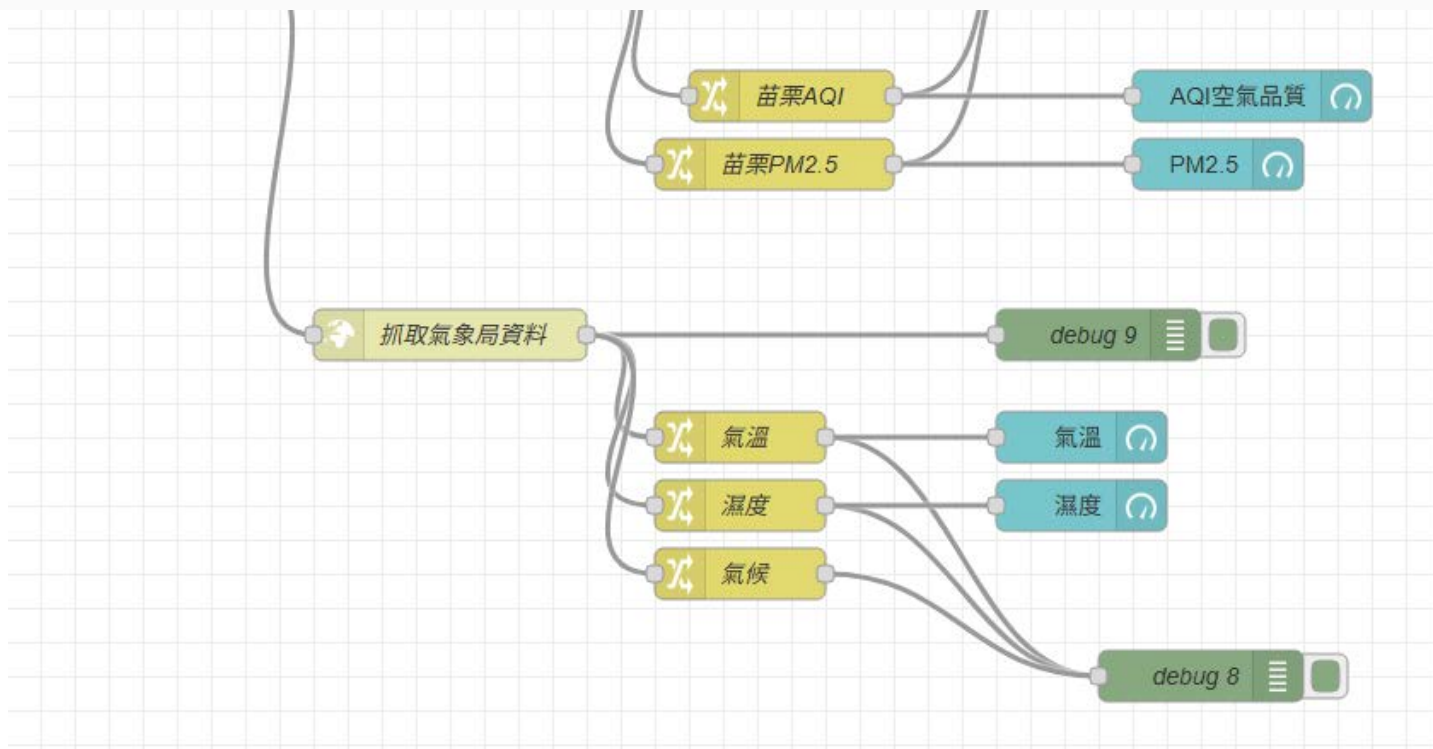

過濾已安裝模組

流程1

流程2

dashboard

- button
- dropdown
- switch
- slider
- numeric
- text input
- date picker
- colour picker
- form
- text
- gauge
- chart**
- audio out
- notification
- ui control
- template

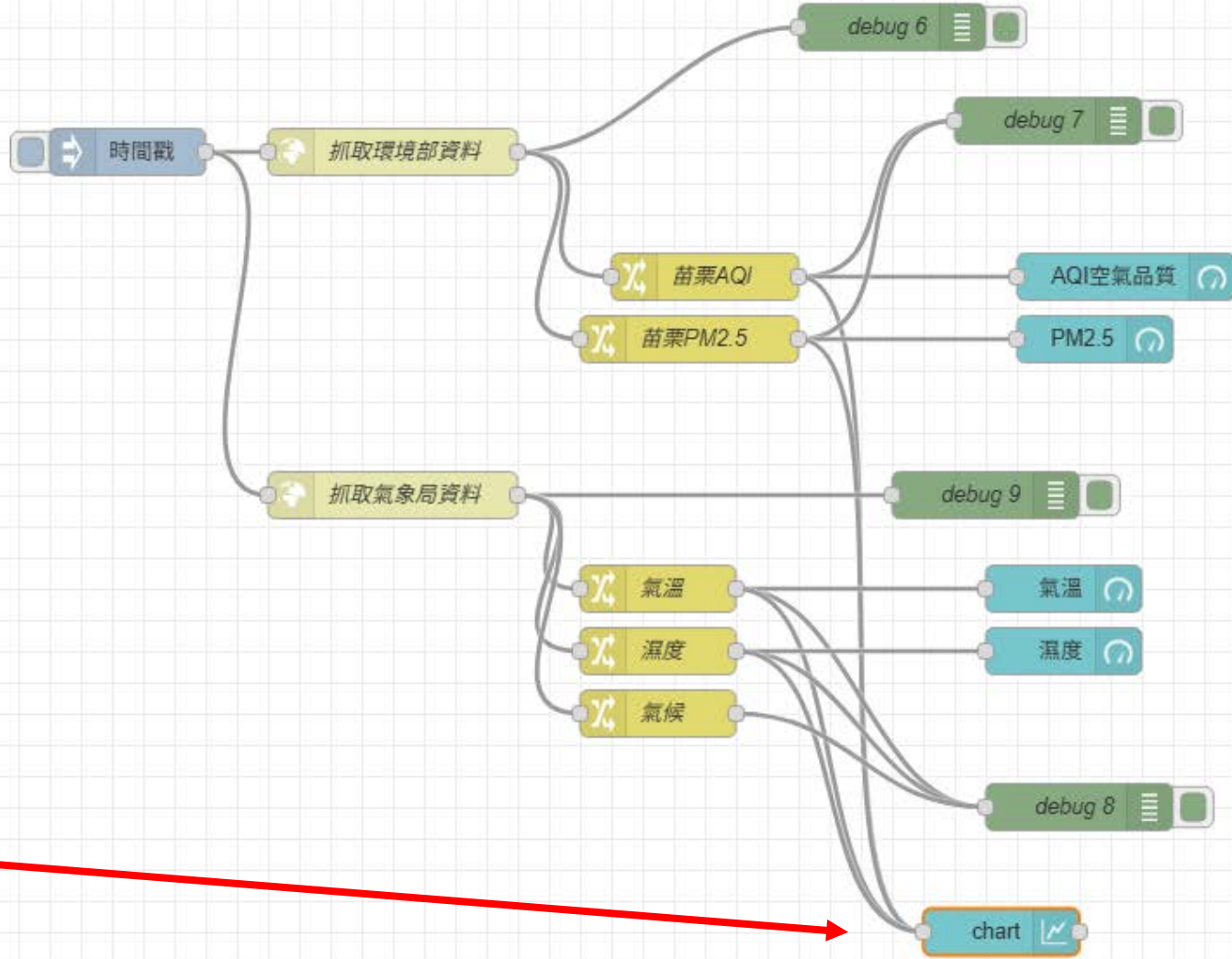

儀表板新增折線圖與即時影像擷取

匯入上週記錄檔：<https://bt.imi.tw/yd0420.txt>

2026.05.03

新增折線圖

日期格式：MM/DD HH:mm

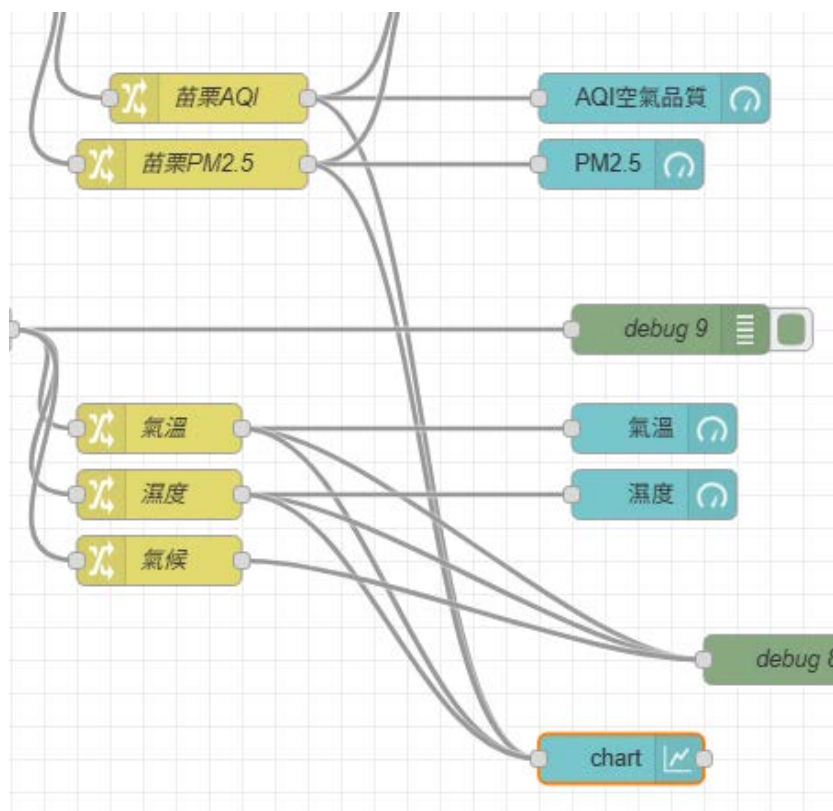

編輯 chart 節點

刪除 取消 完成

屬性

Group [空氣品質與天氣] 苗栗

Size auto

Label optional chart title

Type Line chart enlarge points

X-axis last 5 days OR 1000 points

X-axis Label MM/DD HH:mm as UTC

Y-axis min max

Legend Show Interpolate linear

Series Colours

Blank label display this text before valid data arrives

Class Optional CSS class name(s) for widget

名稱 名稱

有效

排版設定

dashboard

Layout Site Theme

Tabs & Links

空氣品質與天氣

- 苗栗
 - AQI空氣品質
 - PM2.5
 - 氣溫
 - 濕度
 - chart

苗栗

AQI空氣品質 gauge	PM2.5 gauge	氣溫 gauge	濕度 gauge
chart chart			

苗栗

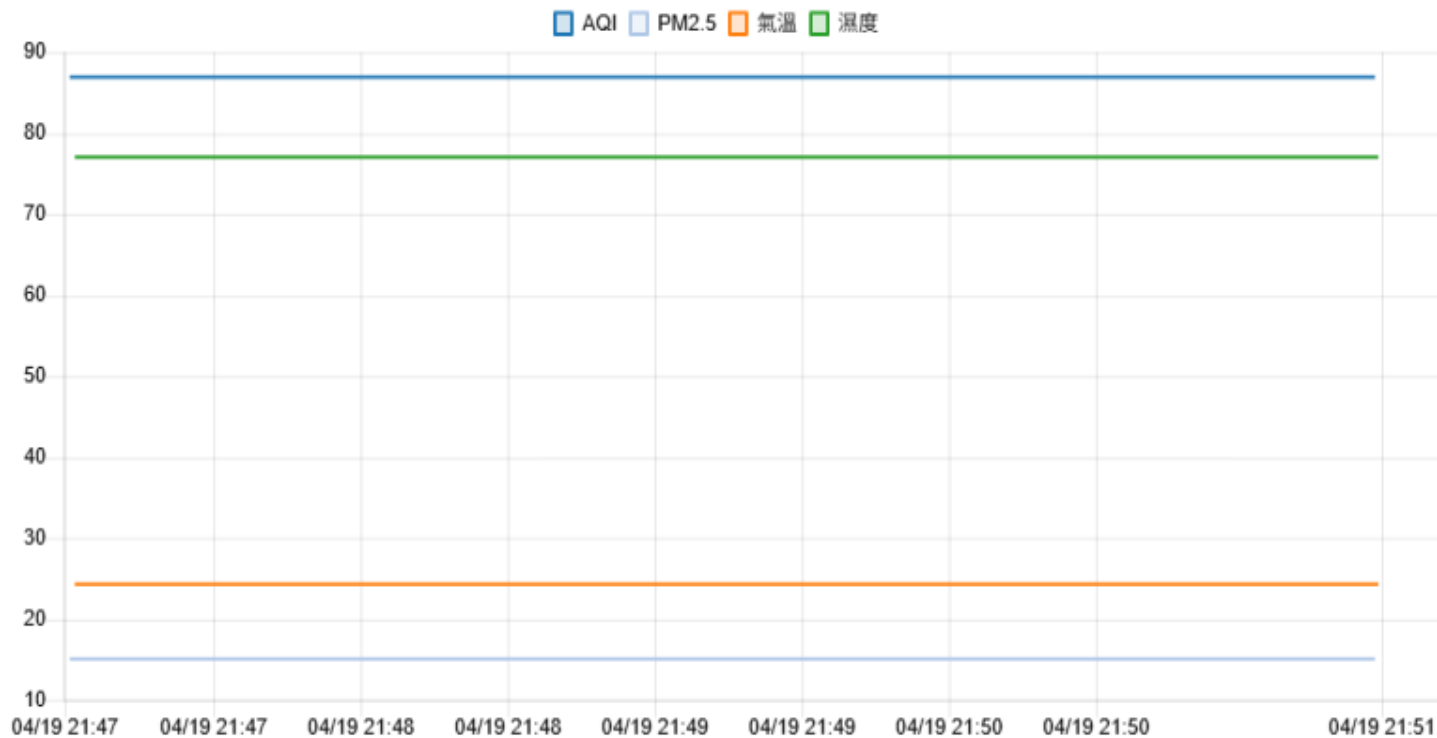
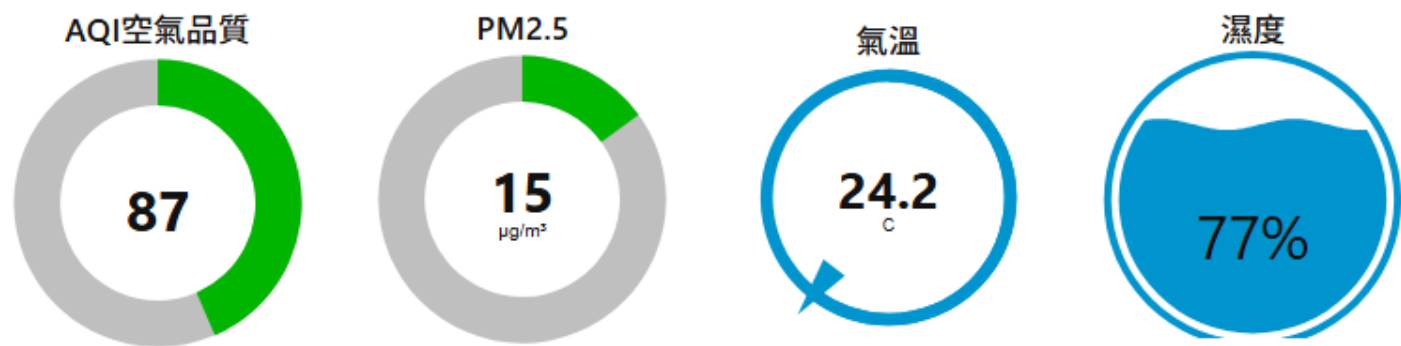

透過AI生成分析程式

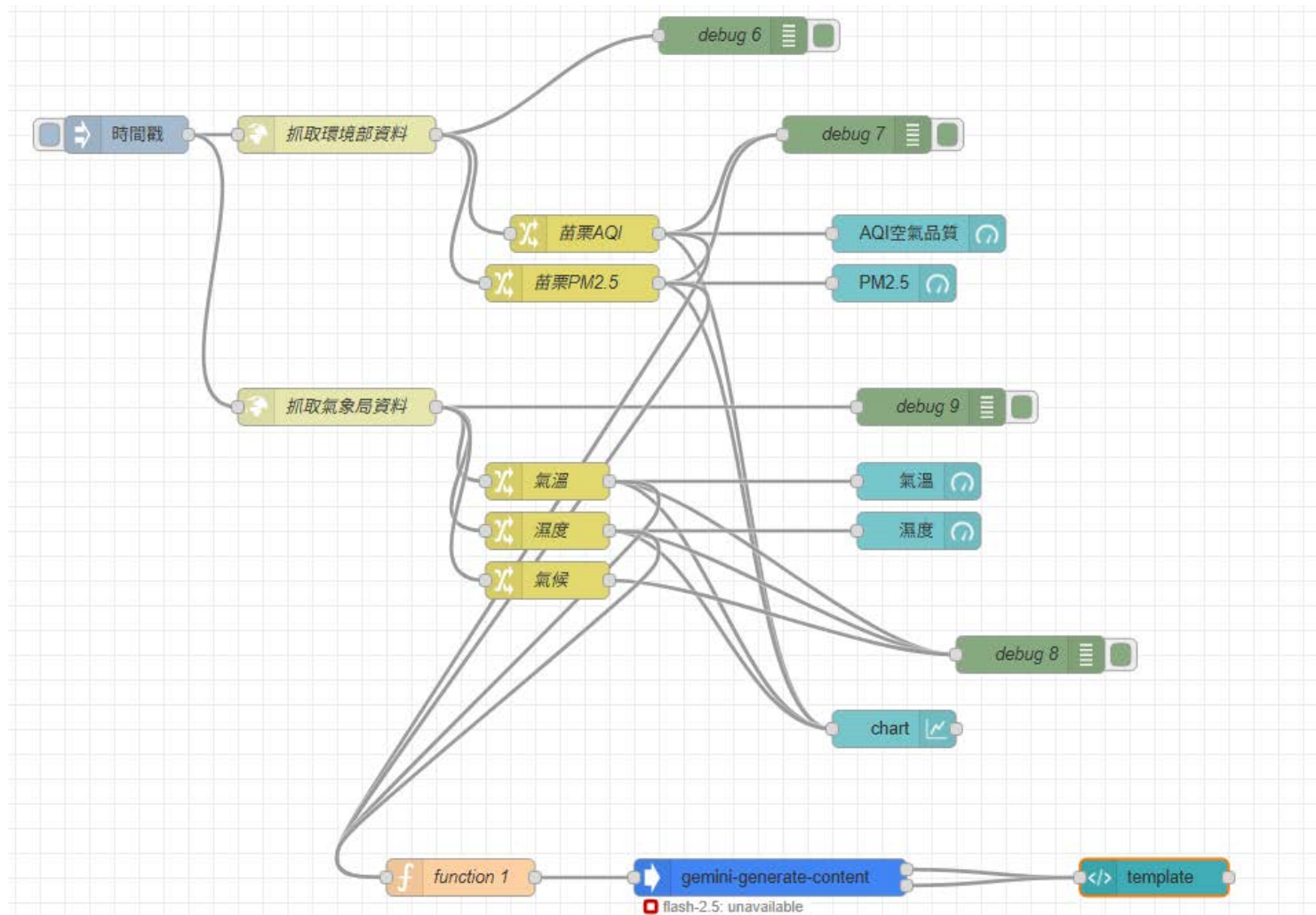

• 打開 **苗栗AQI** 節點：

點擊下方 + add 新增第二條規則：選擇 Set (設定) global.aqi to msg.payload ◦

• 打開 **苗栗PM2.5** 節點：

新增第二條規則：Set global.pm25 to msg.payload ◦

• 打開 **氣溫** 節點：

• 新增第二條規則：Set global.temp to msg.payload ◦

• 打開 **濕度** 節點：

• 新增第二條規則：Set global.hum to msg.payload ◦

FUNCTION 1

```
// 1. 從全域變數讀取你剛剛存好的最新數據 (如果還沒抓到，就顯示"未知")
```

```
let aqi = global.get("aqi") || "未知";
```

```
let pm25 = global.get("pm25") || "未知";
```

```
let temp = global.get("temp") || "未知";
```

```
let hum = global.get("hum") || "未知";
```

```
let weather = global.get("weather") || "未知";
```

```
// 2. 組合給 Gemini 的 Prompt (提示詞)
```

```
msg.payload = `你是一位貼心的苗栗在地生活助理。`
```

```
現在苗栗的天氣是「${weather}」，氣溫 ${hum}度，濕度 ${temp}%。
```

```
空氣品質 AQI 為 ${aqi} (PM2.5: ${pm25})。
```

```
請用繁體中文、50字以內，用親切的語氣告訴我今天出門要注意什麼？(例如穿著或要不要帶傘/口罩)；
```

```
return msg;
```

TEMPLATE

```
<div style="background: #e3f2fd; padding: 15px; border-radius: 10px; border-left: 5px solid #1976d2;">
```

```
  <h4 style="margin-top:0; color: #0d47a1;">💡 AI 助理建議 : </h4>
```

```
  <div style="font-size: 16px; line-height: 1.5; white-space: pre-wrap;">{{msg.payload}}</div>
```

```
</div>
```

苗栗

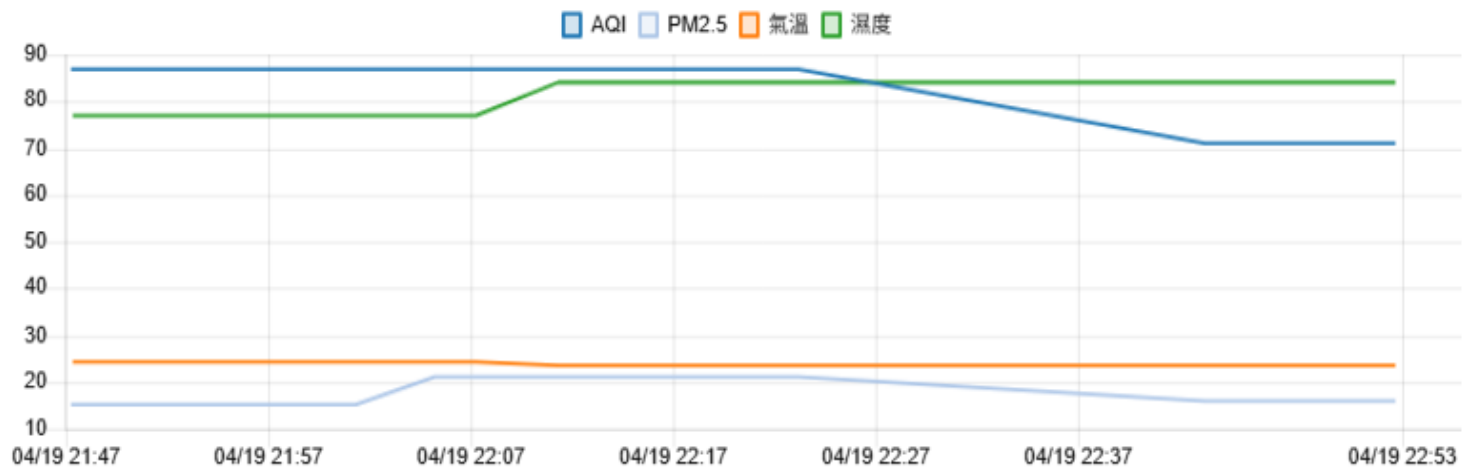
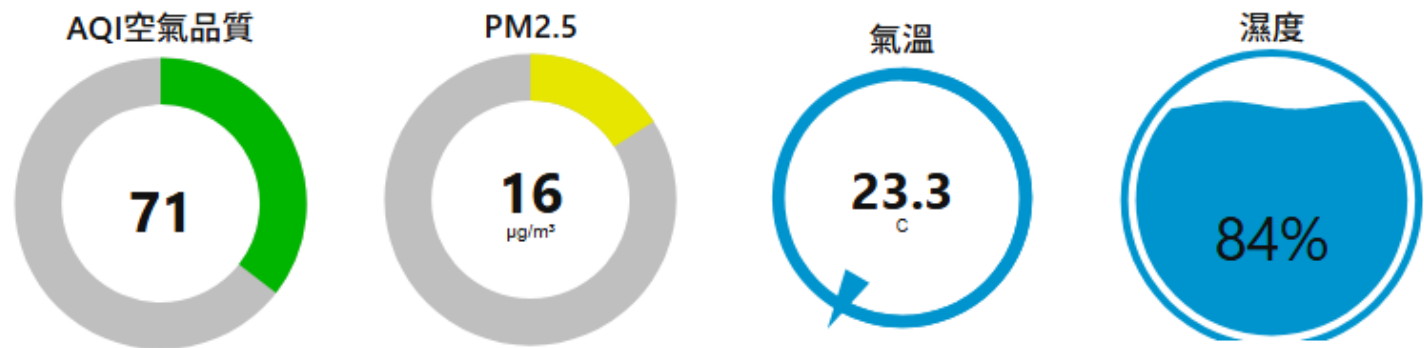

💡 AI 助理建議：

哈囉！苗栗今天23.3度涼爽，穿輕便即可。空氣品質中等，敏感者可備口罩，出門愉快喔！

新增天氣圖示

天氣可能狀況：晴、陰、多雲、陰有雨、陰有雷雨

天氣小圖示：https://www.cwa.gov.tw/V8/E/K/Weather_Icon.html

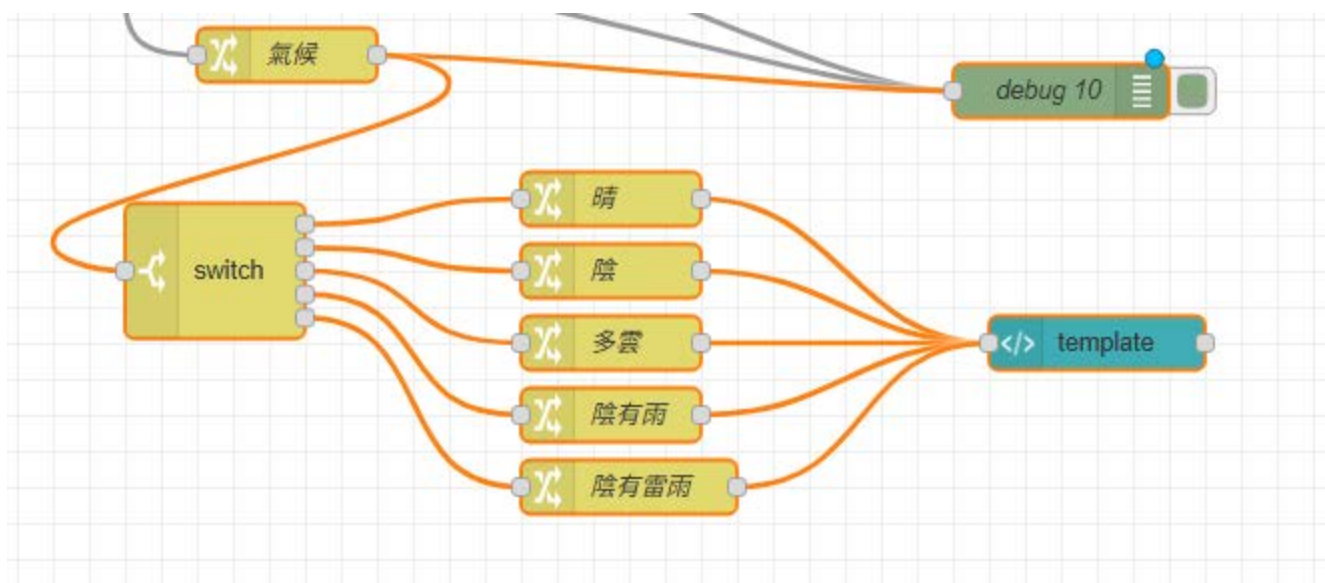

交通部中央氣象署
Central Weather Administration

HOME | 中 | SITEMAP | CONTACT US | FAQ | ABOUT CWA

WARNINGS WEATHER LIFE WEATHER EARTHQUAKES MARINE CLIMATE DATA OUTREACH SERVICE

Strong Wind Advisory | Dismiss Heavy Rain Advisory

FAQ > Weather Icon

Weather Icon

Description	Icon of day	Icon of night
clear		
mostly clear		
partly clear		
partly cloudy		
mostly cloudy		

編輯 switch 節點

刪除

取消

完成

屬性



名稱

名稱

屬性

msg. payload

== 晴 → 1

== 陰 → 2

== 多雲 → 3

== 陰有雨 → 4

== 陰有雷雨 → 5

+ 添加

全選所有規則

重建資訊佇列



有效

編輯 change 節點

刪除

取消

完成

屬性



名稱

晴

規則

設定

msg. payload

to the value

https://www.cwa.gov.tw/V8/assets/img/w

+ 添加



有效

編輯 template 節點

刪除

取消

完成

屬性



Template type

Widget in group

Group

[天氣品質與氣候] 苗栗

Size

4 x 5

Class

Optional CSS class name(s) for widget

名稱

名稱

Template

```
1 :enter>天氣</p>
```

- Pass through messages from input.
- Add output messages to stored state.
- Reload last value on refresh.



有效

```
<p align=center>天氣</p>
```

天氣圖示完成

苗栗

天氣



空氣品質

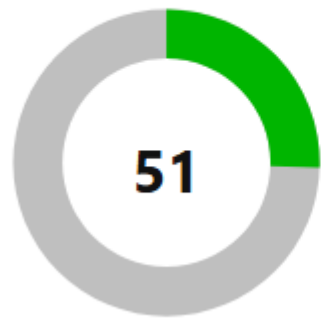

PM2.5

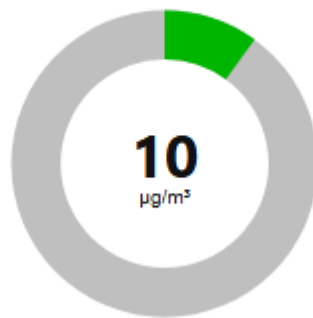

濕度

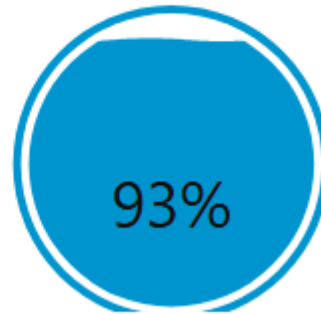

氣溫



台灣即時影像擷取

安裝套件1：node-red-contrib-multipart-stream-decoder

安裝套件2：image-output

網址：tw.live

使用 multipart decoder 貼上影像網址

將輸出 output 改為 **a binary buffer**

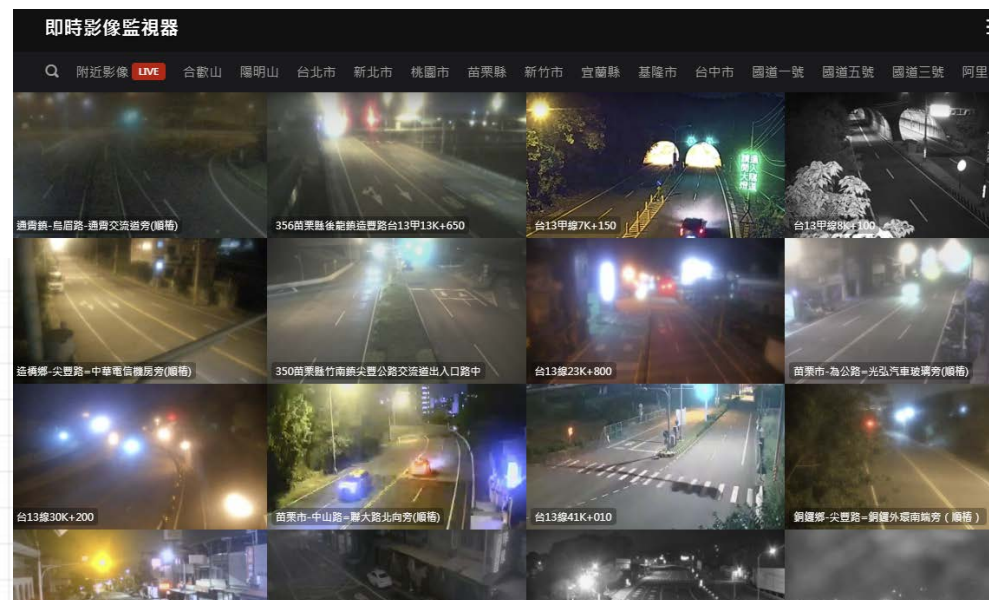
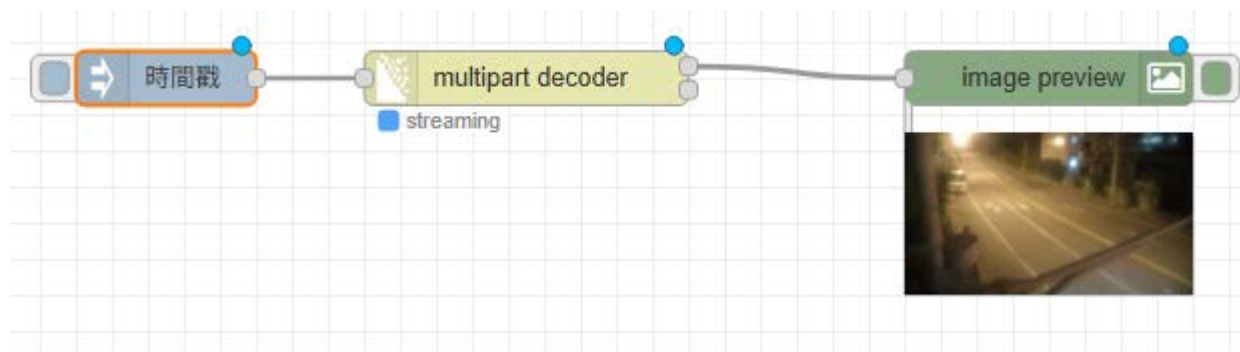

新增擷取影像節點

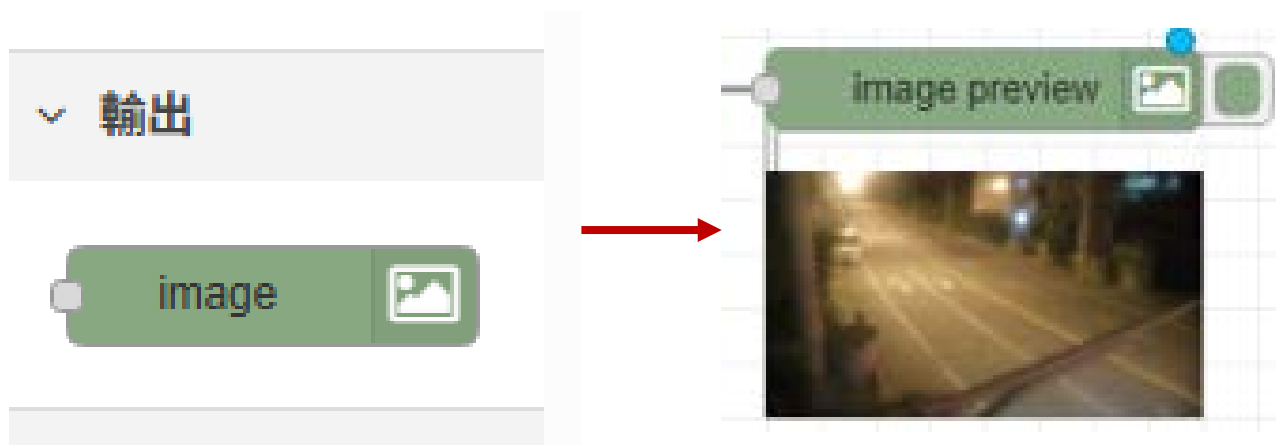

編輯 multipart-decoder 節點

刪除

取消

完成

屬性

Name

common.label.name

URL

https://cctv-ss04.thb.gov.tw/T13-16K+050

Enable secure (SSL/TLS) connection

複製連結

Authenticate Basic

Username

Password

Output

a binary buffer

修改

Delay

0

Block size

1

Max. size

1000000

Debug log

Off

有效

有效

DASHBOARD呈現影像

安裝套件：node-red-node-base64

template語法

```
<p align=center>造橋鄉-尖豐路</p>
```

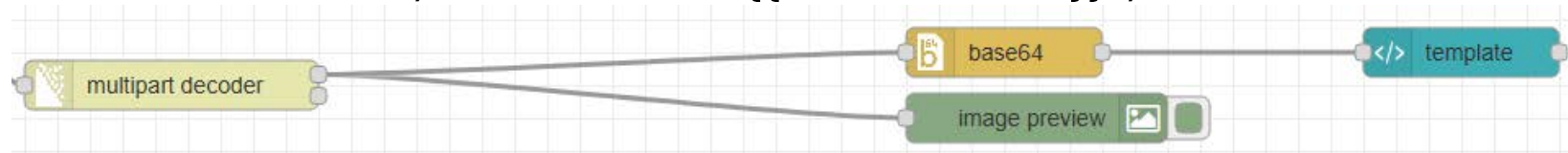

三義鄉-水美街



台1線92K



苗140與台61線交接



造橋鄉-尖豐路

